

### Chain Bracket

Part Number	SIZE
MBK516	5/16"
MBK38	3/8"



### 1/4X28" Safety Chain S Hook

Part #: MCH14Z

Description:



### 5/16X28" Safety Chain S Hook

Part #: MCH516Z

Description:



### 5/16X34" Safety Chain Clevis Hook

Part #: MCH516Y

Description:



### 3/8X36" Safety Chain Clevis Hook

Part #: MCH38Y

Description:



## Seven Way Truck Side Plug

Part #: MPG835



## Seven Way Trailer Plug

Part #: MPG717RV

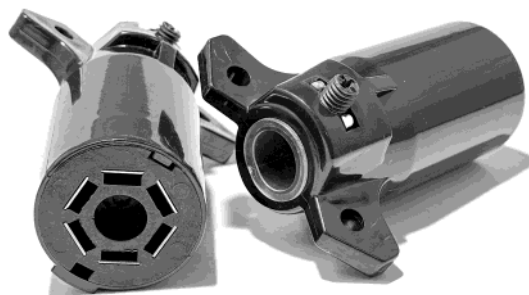

## Front Trailer Harness Seven Way Molded Plug

Part Number	Length (L)
MWH12-5020-01	84"
MWH12-5020-00	120"



## 4 Wire Front Harness

Part Number	Length (L)
MWH12-5020-04	60"
MWH12-5020-72	72"



## Flat Four Way Plug Female 16"

Part #: MWH416

Description: Wires are 16" long

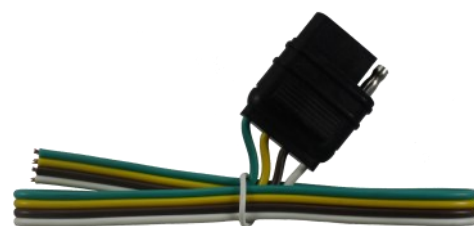

## 1" Wire Harness Clip

Part #: MHC130

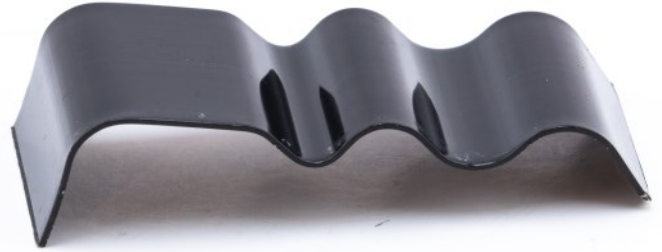

## Complete Rear Single Light Wire Harness

Part #: MWH12-5088-00



## Complete Rear Double Light Wire Harness

Part #: MWH12-5084-00



## 25' Wire Harness

Part #: MWH25W/4P

Description: Four pin plug with two brown wires



## Triple Two Pin Plug Harness

Part #: MWH32PIN

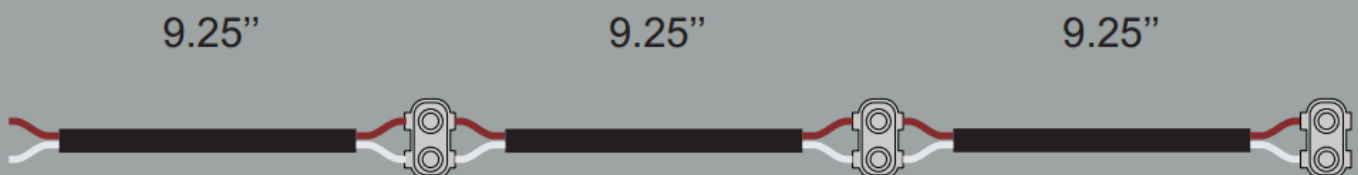

## Mid Harness 24-26

Part #: MWH2426

Description:  
Gooseneck Midsection  
Harness

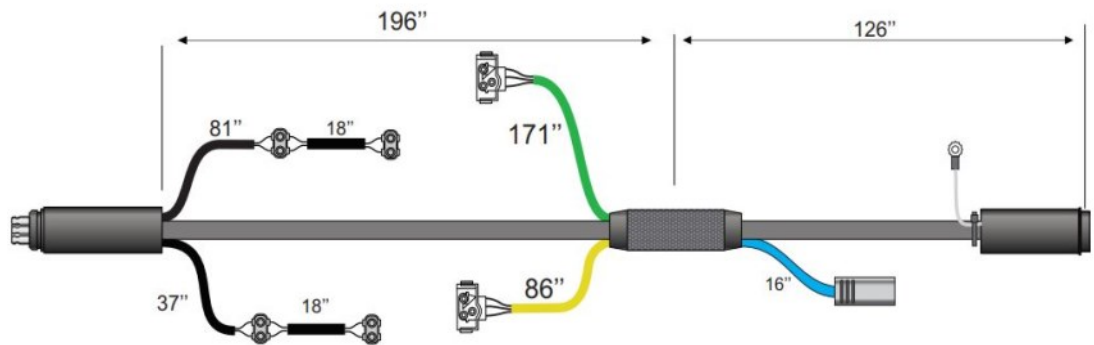

## Mid Harness 32-34

Part #: MWH3234

Description:  
Gooseneck Midsection  
Harness

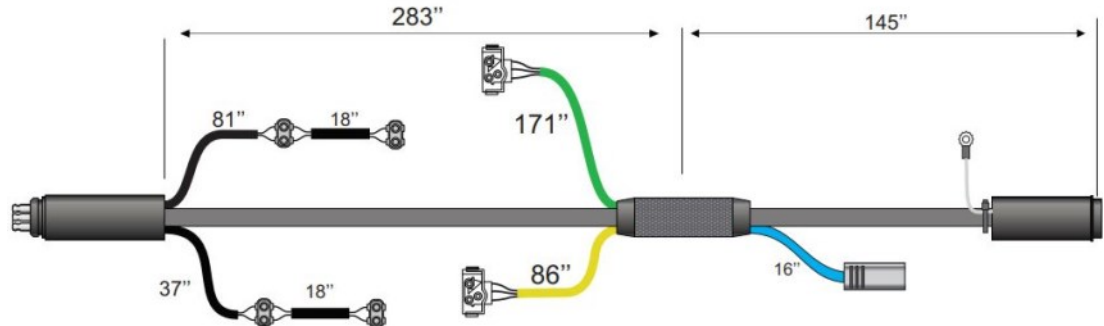

## Mid Harness 40ft

Part #: MWH40

Description:  
Gooseneck Midsection  
Harness

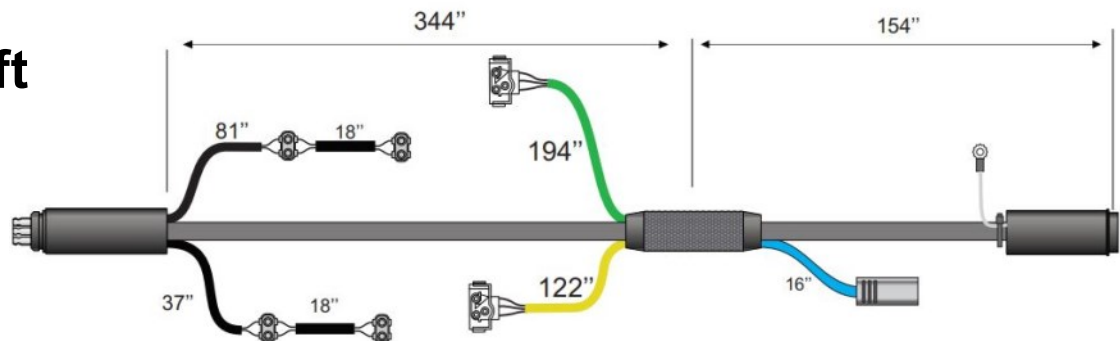

## Mid HARNESS 16-18

Part #: MWH1618

Description:  
Car Hauler Midsection  
Harness

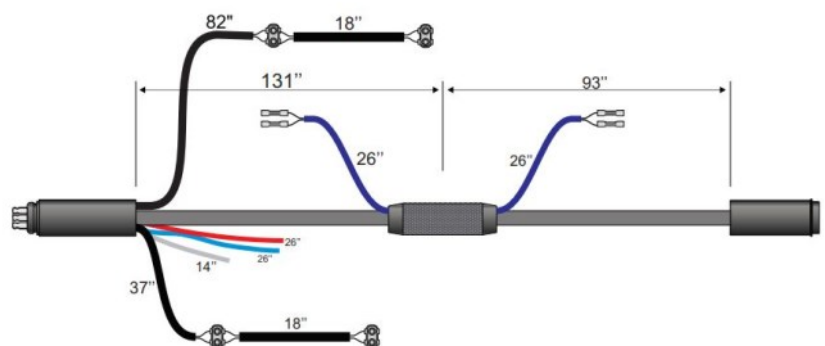

## Mid Harness 20-22

Part #: MWH2022

Description:  
Car Hauler Midsection  
Harness

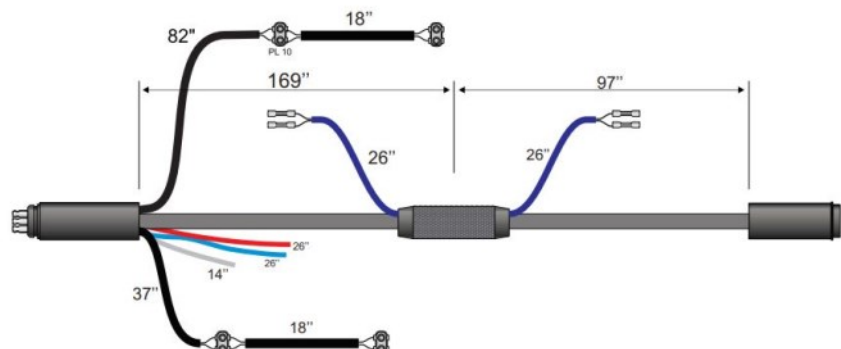

## Front Gooseneck Harness -40° rating

Part #: MWH276

Description:

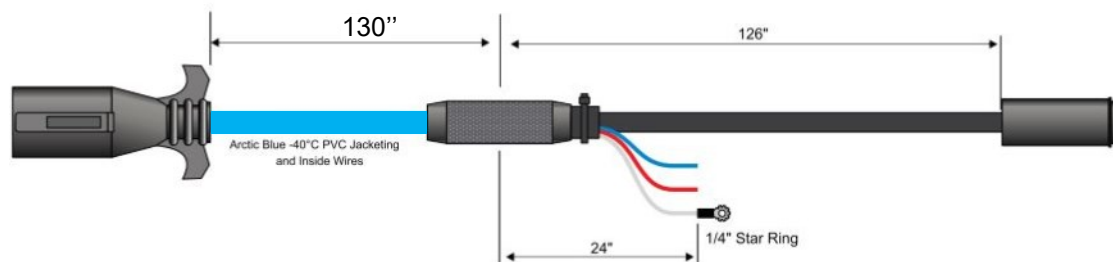

## Car Hauler Front Harness -40° rating

Part #: MWH89B

Description:

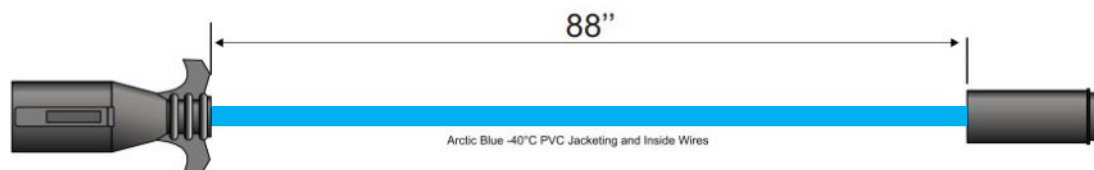

## Deck over Rear Harness 2Pin Plugs

Part #: MWH102

Description:

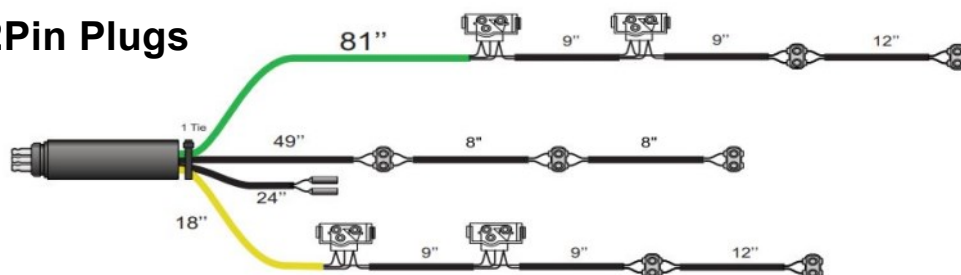

## Deck over Rear Harness Bullet Light Plugs

Part #: MWH102B

Description:

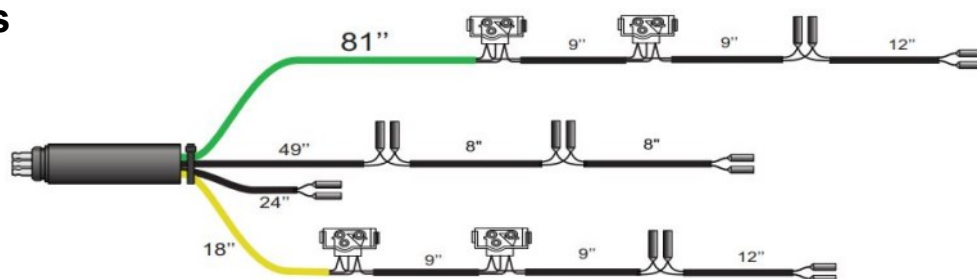

## Gooseneck Brake Harness

Part #: MWH2022

Description:

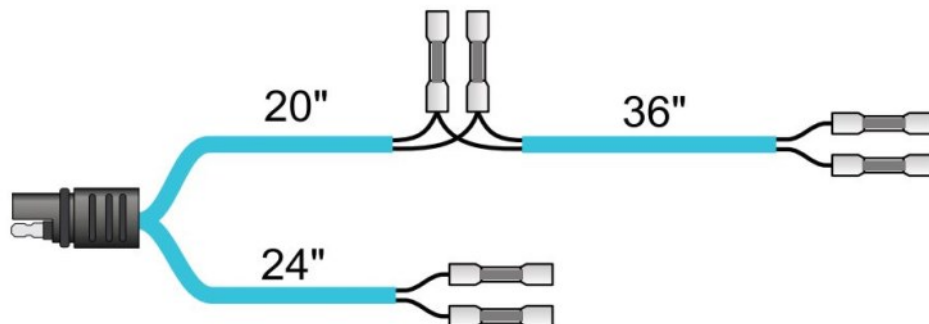

## 10ft DUMP MID SECTION HARNESS

Part #: MWHD10DM

Description:

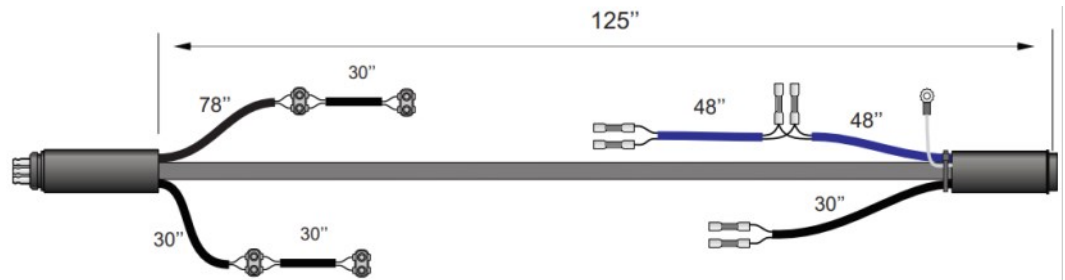

## 12ft DUMP MID SECTION HARNESS

Part #: MWH12DM

Description:

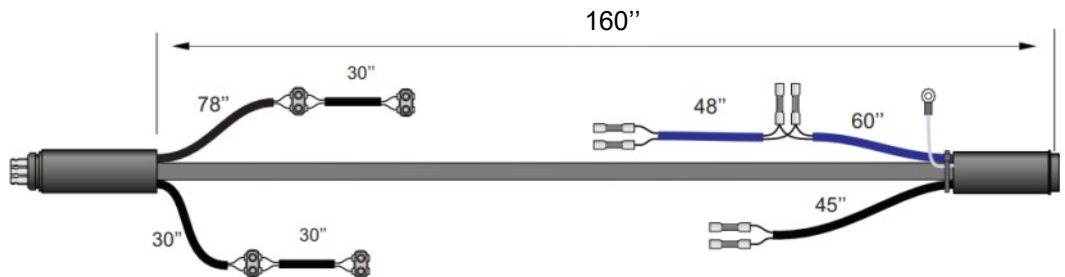

## 16ft DUMP MID SECTION HARNESS

Part #: MWH16DM

Description:

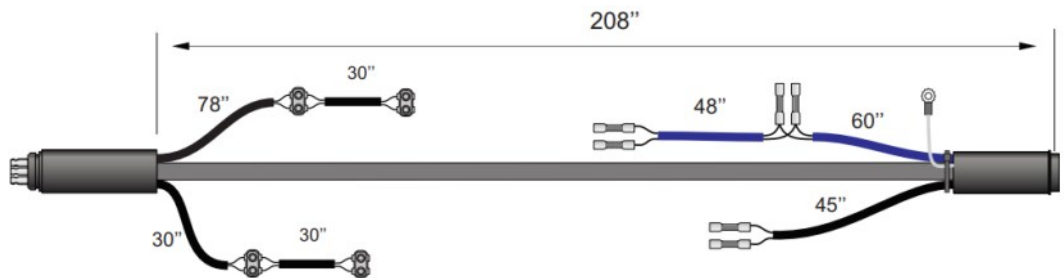

## Dump Rear Harness 2Pin Plugs

Part #: MWH88D

Description:  
For dumps 16ft and shorter

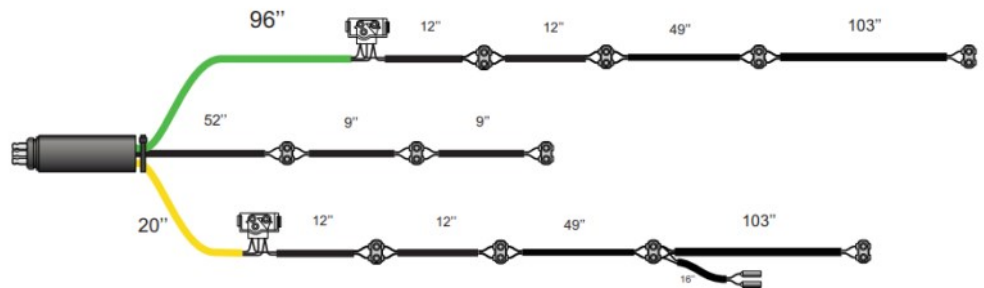

## Dump Rear Harness Bullet light plugs

Part #: MWH88DB

Description:  
For dumps 16ft and shorter

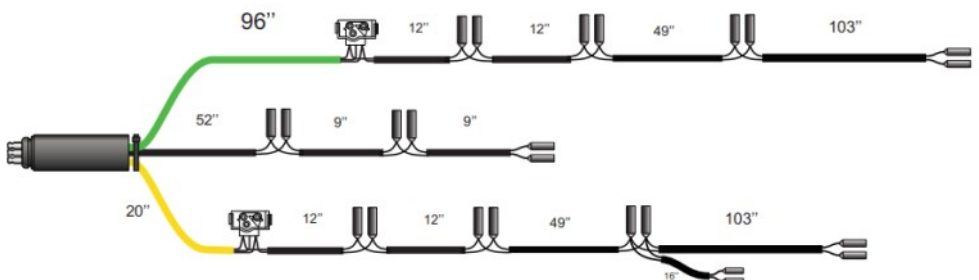

## Dump Goose Neck Harness

Part #: MWHD120F

Description:

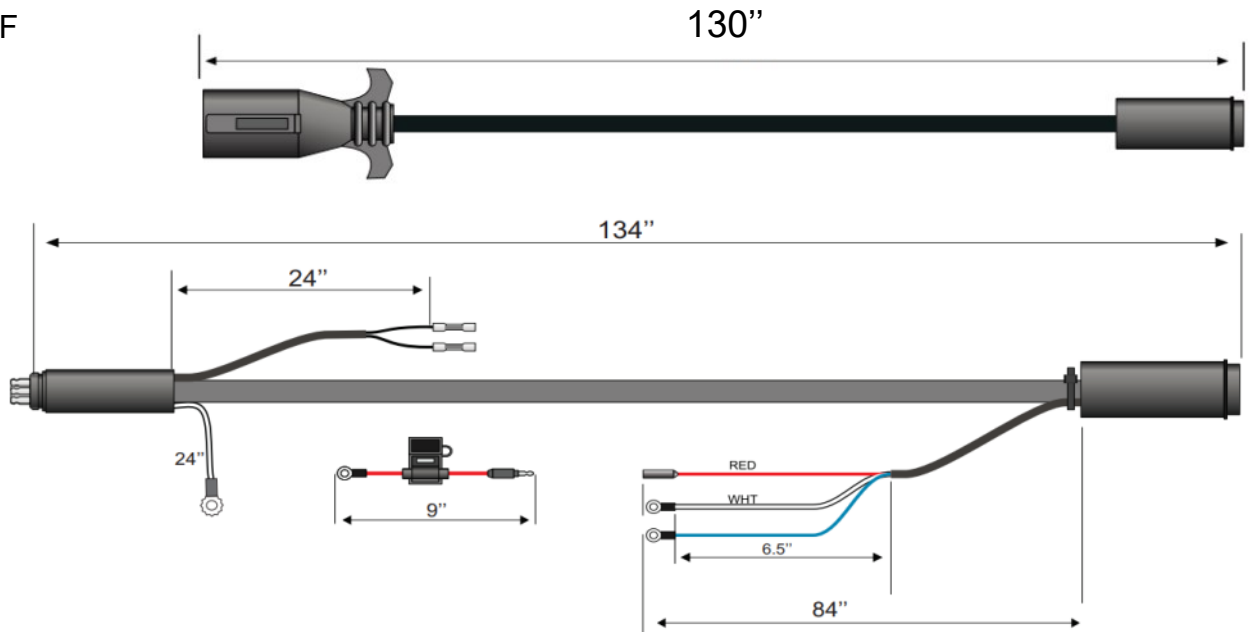

## Bumper Pull Dump Harness

Part #: MWHD89D

Description:

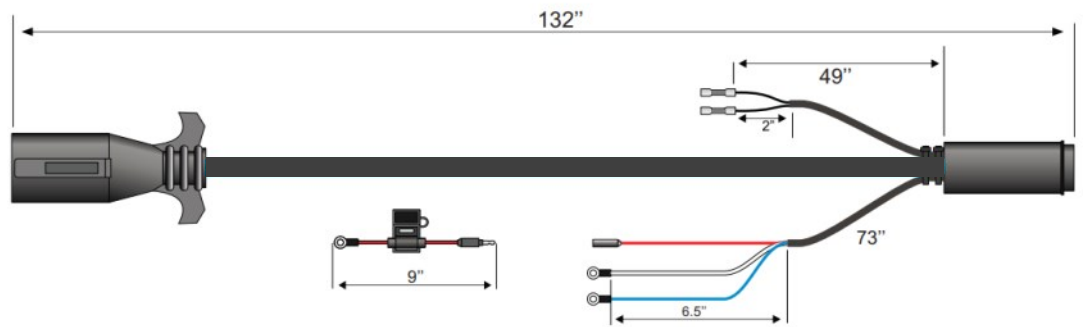

## Car Hauler Rear Harness w/Bullet Light Plugs

Part #: MWH83B

Description:  
Car Hauler  
Rear Harness

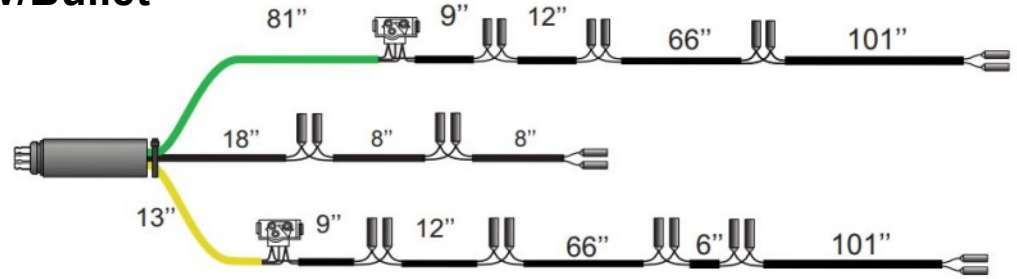

## Car Hauler Rear Harness w/2Pin Plugs

Part #: MWH83

Description:  
Car Hauler  
Rear Harness

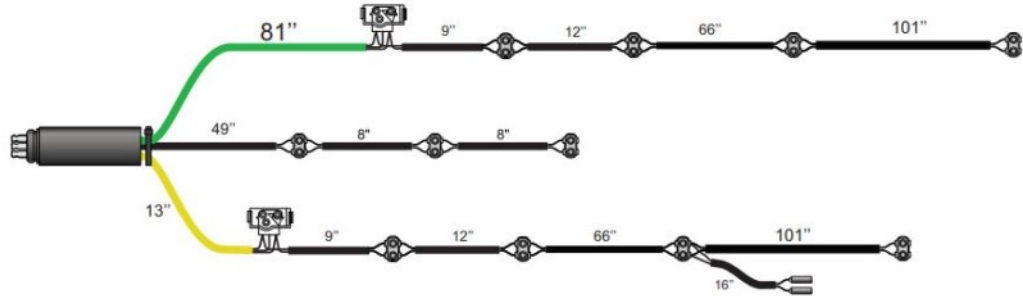

## 24" Extension for Main Harness

Part #: MWH2

Description:

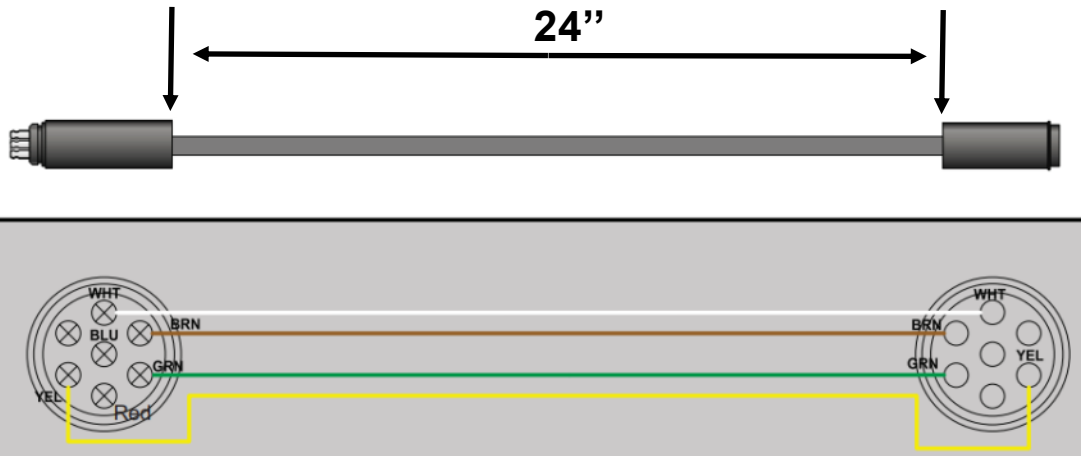



**Bullet light  
To  
2Pin Plug  
Adaptor**

**Part #:**  
MWHADAPTERBULLET

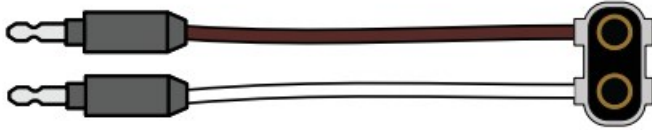

**2Pin Plug  
To  
Bullet light  
Adaptor**

**Part #:**  
MWHADAPTER2PIN

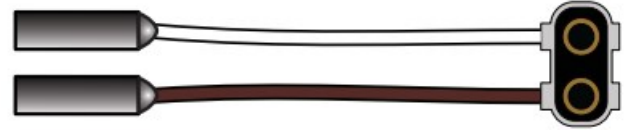

**3Pin Connectors**

**Part #:** MCT323



**2Pin Connectors**

**Part #:** MCT223



**Wire Loom 1/2"**

**Part #:** MWLC12

Description:  
**Wire sleeve**



**Heat Shrink WIRE  
Connector**

**Part #:** MBC1210

**Description:** Pack of 500



**Heat Shrink WIRE  
Connector**

**Part #:** MBC1412

**Description:** Pack of 1000



## 6 WIRE CABLE

Part #: MWC1418-6

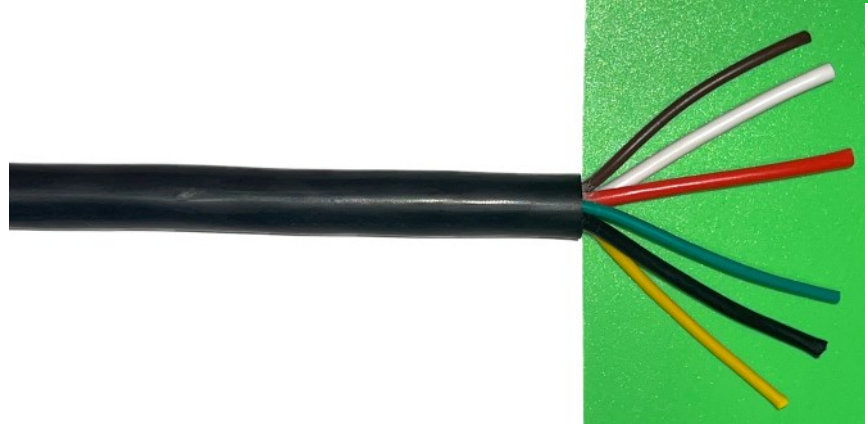

## 5 WIRE CABLE

Part #: MWC1418-5



## 4 WIRE CABLE

Part #: MWC18-4



## 3 WIRE CABLE

Part #: MWC18-3



## 2 WIRE CABLE 16G GRAY SLEEVE

Part #: MWC16-2



## 2 WIRE CABLE 14G RED SLEEVE

Part #: MWC14-2



### Two Terminal Junction Box

Part #: MJB11-060



### Seven Terminal Junction Box

Part #: MJB11-100



### Steel License Plate Bracket

Part #: MB2024S



### 3 LED 3 Red Light Bar Bracket

Part #: MLED57353BR

Description: Each Light contains 3 LEDs



### Removeable 1/2" D-ring

Part #: MSP355

Description: Stake pocket D-ring



## Zip Ties

Part Number	Size
MZT4150	6"
MZT5200	8"
MZT5280	11"



## Drill Bits



Part number	SIZE
MDB18	1/8"
MDB316	3/16
MDB250	1/4"
MDB516	5/16"
MDB716	7/16"
MDB7324	7/32"
MDB38	3/8"

Part number	SIZE
MDB12	1/2"
MDB916	9/16"
MDB932	9/32"
MDB58	5/8"
MDB34	3/4"
MDB1332	13/32"
MDB100	1"

## T Handle Latch

Part #: ML 484501

Description:



## Paddle Handle Latch

Part #: ML 405

Description:



## SS Cam Latch

Part #: ML 457501

Description:  
Stainless Steel toolbox handle



## 7" Toggle Clamp w/safety

Part #: MLT48786

Description:

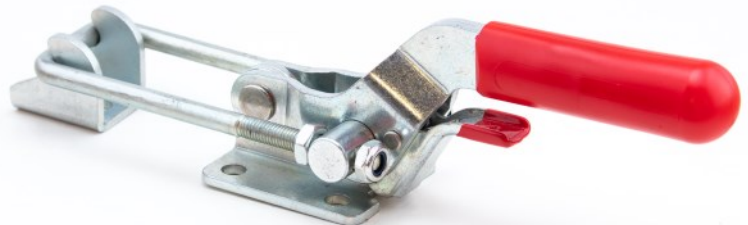

## 1/2" Dead Bolt Latch

Part #: ML1232

Description:



**Dead Bolt Latch (Left)**

Part #: ML346L



**Dead Bolt Latch (Right)**

Part #: ML346R



**2"x1.5" Bolt Latch with Ring**

Part #: ML215



**3/8" Toolbox Han-**

Part #: MHD156

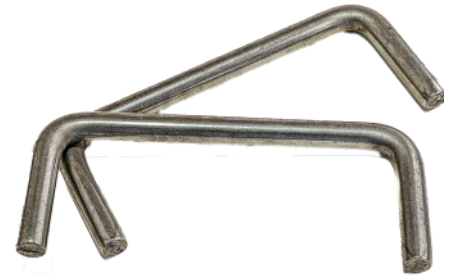
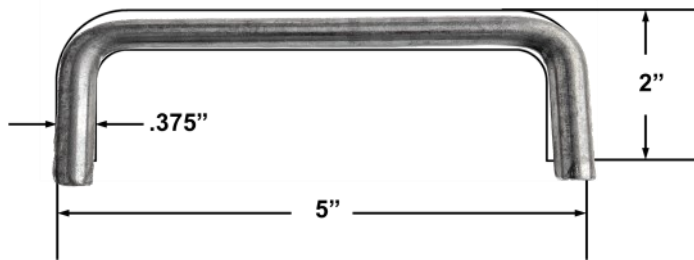

**Hasp Handle Lock**

Part #: MHP15HSP

**1" Flat Handle**

Part #: MHD15HDL

**1" Rubber Flat Handle Sleeve**

Part #: MHRS100

**Rubber Sleeve 3/4"**

Part #: MSL1340

**Rubber Sleeve 1/2"**

Part #: MSL120



**Top Lug C****Part #:** MLG15C**Description:** Lug for door latch**Bottom Lug D****Part #:** MLG15D**Description:** Lug for door latch**Keeper A****Part #:** MKP15A**Description:** Keeper for door latch**Keeper B****Part #:** MKP15B**Description:** Keeper for door latch**Heavy Duty Dump Door Hinge with Greaser****Part #:** MHG003



**Dump Door Latching Stop**

Part #: MLT 1225

Description:

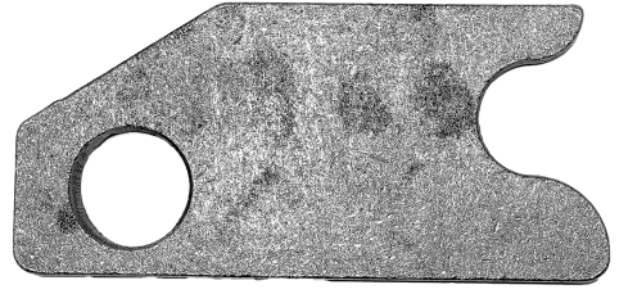
**Dump Door Latch**

Part #: MLT 1260

Description:

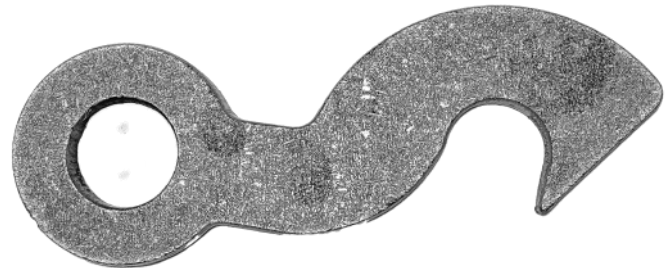
**Dump Door Latch Handle**

Part #: MLT 1214

Description:

**L-Shaped Dump Door Hinge**

Part #: Mhg 1230

Description:

**D-Shaped Dump Door Hinge**

Part #: Mhg 1210

Description:



## 3" Butterfly Hinge

Part #: MHG33

Description: Weld-on hinge



## Bullet Hinge with Greaser

Part Number	Size
MHG60	2"
MHG80	3"
MHG100	4"
MHG120	5"
MHG180	6"
MHG200	8"



### Stabilizer Pin

Part #: MPN781

Description: Hole is 7/16"



### 7/16" Linch Pin

Part #: MPN791

### 3/4" Pin with Cotter Pin

Part #: MPN342

Description: Pin Length 2"



### 3/8" Pin with Cotter Pin

Part #: MPN38



### 5/16" Pin with Cotter Pin

Part #: MPN516



### Cotter Pin

Part Number	Size
MPN18X112	1/8" x 1 1/2"
MPN323X100	3/32" x 1"



**3/4" Coupler Pin w/Clip****Part #:** MPN346**Description:** Length of pin is 6"**5/8" L-Shaped Pin w/Clip****Part #:** MPN584**Description:** Length of pin is 4"**1/2" L-Shaped Pin w/Clip****Part #:** MPN123**Description:** Length of pin is 3".

# MUSTANG ENTERPRISE Receivers & Hitch Balls

## 6" Receiver Tube

Part #: MRT6



## 12" Receiver Tube

Part #: MRT12



## 5/8" L-Shaped Pin w/Clip

Part #: MPN584

Description:  
Receiver pin  
Length of pin is 4"



## Receiver Tube Chain Bracket

Part #: MRTCB375



## Hitch Ball

Part Number	Ball Diameter	Shank Diameter	Shank Length
MHB21	2"	1"	2"
MHB25161	2 5/16"	1"	2"



### Chain Bracket 3/8"

Part #: MBK38

Description: Steel chain bracket



### Chain Bracket 5/16"

Part #: MBK516

Description: Steel chain bracket



### Fender Bar Light Bracket - Smooth

Part #: MLBFBS80

Description: Bracket for 2" light



### Fender Bar Light Bracket - Diamond Plate

Part #: MLBFBD80

Description: Bracket for 2" light



### Front Light Bracket

Part #: MLB358

Description: Bracket for 2" light

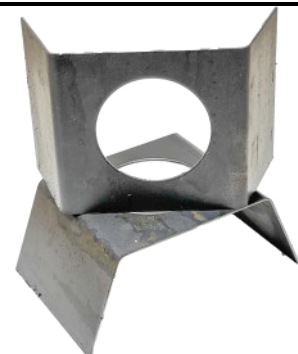

## Goose Neck Step

Part #: MSP148



## Weld-on Tab

Part Number	Size
MWT1316	1 3/16"
MWT158	1 5/8"

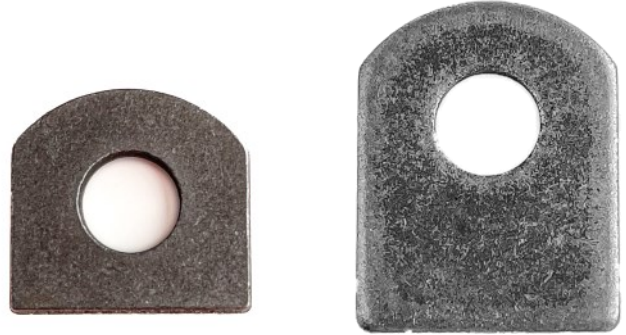

## 14" Lid Prop

Part #: MLP14



## Ramp Helper Spring

Part Number	Side
MS468170L	Left
MS468170R	Right

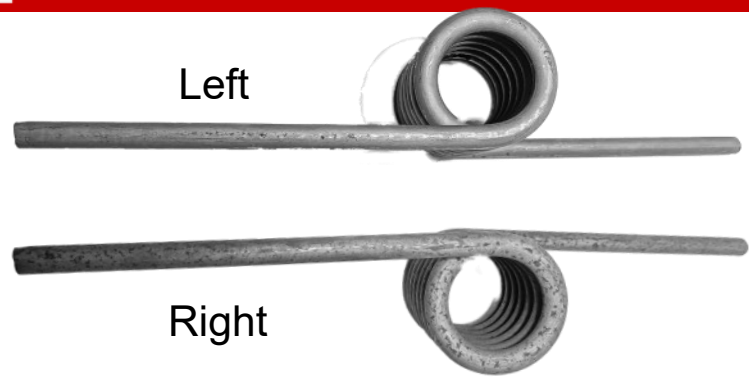

## Gate Helper Spring

Part Number	Side
MS120L90B	Left
MS120R90B	Right



## 1" x 7" Return Spring

Part #: MSP170



## Air Spring

Part Number	Size
MAS610	10" 35lbs
MAS612	12" 40lbs



## Air Spring Bracket

Part #: MBK10





## Hydraulic Cylinder Pressure Sticker

Part #: MSTHYC

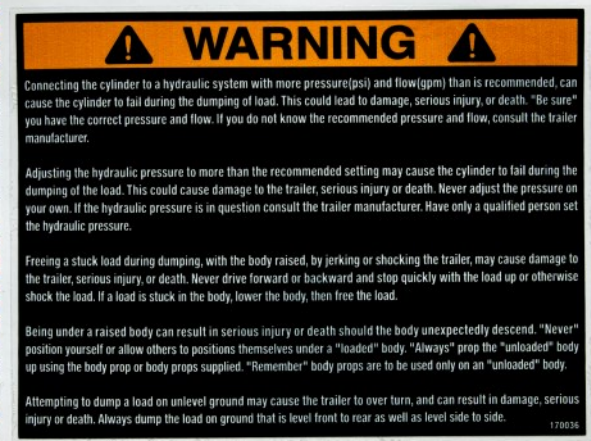

## Pinch Sticker

Part #: MSTPINCH



## Stand Clear Dump Sticker

Part #: MSTDUMP



## 25,000 lbs Coupler Sticker

Part #: MST25KC

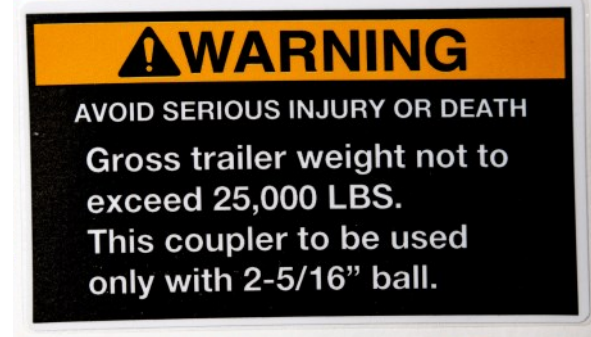

## Multi Warning Sticker

Part #: MST1230

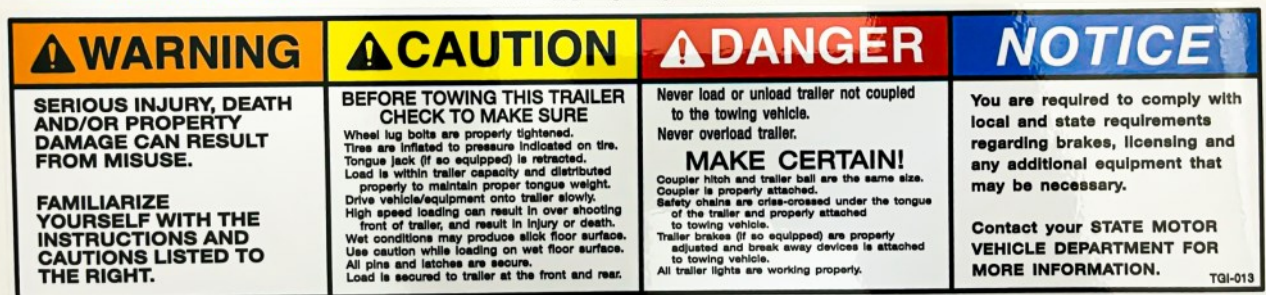

## Kiss Cut Reflective Tape

**Part #:** MRTP66

**Description:** Kiss Cut 150' x 2" Roll Tape  
6" white / 6" red



## Reflective Sticker - Red QTY525 pcs Per Roll

**Part #:** MRTS235R



## Reflective Sticker - Amber QTY525 pcs Per Roll

**Part #:** MRTS235A



## White Reflective Tape

**Part #:** MRTP12W



## In Floor D Ring

Part #: MFR44

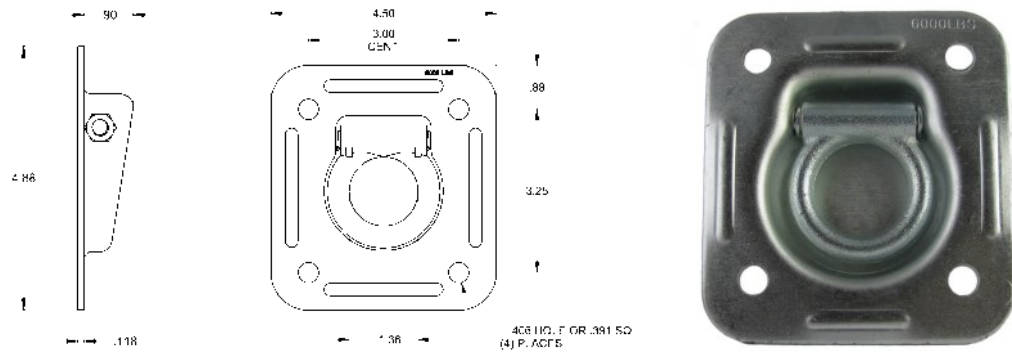

## J Hook

Part #: MJH38339



## 3/8" Wire Clamp

Part #: MCK38



## 1/2" Wire Clamp

Part #: MCK12



## Pipe clip for 1 1/4" pipe 5/16" thick

Part #: MCP114



**1/2" Weld On D-Ring**

Part #: MDR120

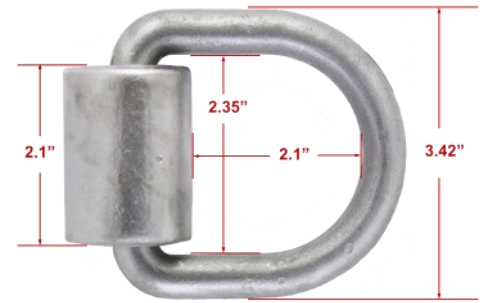
**5/8" Weld On D-Ring**

Part #: MDR580

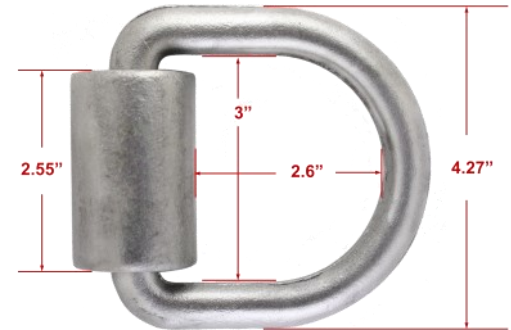

---

## Cutting Torch

**Part #:** MCT135

**Description:** Cutting torch will fit Victor Handle and tip.



# MUSTANG ENTERPRISE

**14" Chop Saw Blade - Made in Germany**

**Part #: MCD64502**



**4 1/2"X1/4"X7/8" Grinding Disk**

**Part #: MGW80158**



**4 1/2"X1/4"X7/8" Grinding Disk**

**Part #: MGW80108**



**4 1/2"X1/4" Grinding Disk w/5/8"-11 Nut**

**Part #: MGW4125**



**4 1/2"X1/4" Grinding Disk w/5/8"-11 Nut**

**Part #: MGW80107**



**4 1/2"X1/16"X7/8" Cutting Disk**

**Part #: MCD31152**



**4 1/2"X3/32"X7/8" Cutting Disk**

**Part #: MCD31358**



**Wire Brush  
2 3/4"X5/8 -11**

**Part #: MBR83071  
Wire 0.20"**



**Part #: MBR350  
Wire 0.20"**

## Spare Mount Bolt

Part #: MBT1215



## Wheel Lug Nut

Part #: MNT1220



## Push Nut 1/2"

Part #: MNT121



## Floor Screws

Part Number	Size
MFS14214	1/4" x 2 1/4"
MFS516214	5/16" x 2 1/4"



## Round End Cap

**Part #:** MCAP2.5

**Description:** Measures 2 1/2" for 2 3/8" Pipe



## Square End Cap

Part Number	Size
MCAP1.51.5	1 1/2" x 1 1/2"
MCAP22	2" x 2"
MCAP21	2" x 1"





### Gasket Bulb Side Trim Groove 1/2"

Part #: MGT120



### Gasket Bulb Bottom Trim Groove 5/8"

Part #: MGT580



### Fender Flare Trim 1/4" x 3/8"

Part #: MFT1438



### Hollow D Shape Gasket

Part #: MGT1258

